

16/24 Ports PoE switch

User Manual

Preface



The user manual mainly introduces the product appearance, specification, hardware installation, Web management and other related information.

Illustration

(1) Format of Graphics Interface

Format	Description
< >	"<>" means button name , such as "click <Confirm> button" .
[]	"[]" means window name, menu name and data table, such as "pop out [New user] window" .
/	"/" is used to separate Multi-level menu. Such as [file/new/folder] multi-level menu [file] menu [new] sub-menu [folder] menu option.

(2) Various Signs

 Caution	Improper operation may damage the device or cause data loss.
 Instruction	Supplemental instruction for operation contents.

Content

1 Product Introduction	1
1.1 Overview	1
1.2 Product Feature.....	1
1.3 Board Diagram	2
1.4 Specification	3
2 Installation	4
2.1 Shipping List.....	4
2.2 Installation Precautions.....	4
2.2.1 Safety Precautions	4
2.2.2 Installation Requirements.....	5
2.2.3 The Requirements of Electromagnetic Environment	5
2.3 Installation Way	6
2.3.1 Rack Installation	6
2.3.2 Workbench Installation	7
2.3.3 Wall-hung Installation	7
2.4 Cable Connection.....	8
2.4.1 Device Connection	8
2.4.2 Configuration Cable Connection	8
2.4.3 Power Line Connection	8
3 PoE Web Management Page	9
3.1 Preparation Work	9
3.2 Set up Network Connection.....	9
3.2.1 Set Static IP Address of Managed PC	9
3.2.2 Confirm the Network Connection by Ping Command	11
3.2.3 Cancel the Proxy Server.....	11
3.3 Operating Guidance of Web.....	12
3.3.1 Start and Login	12
3.3.2 Operating Instruction of Web	14
3.4 Typical Application	22
3.5 Troubleshooting	22

1 Product Introduction

1.1 Overview

The 16/24 ports PoE switch is an unmanaged PoE Ethernet switch along with 16/24 * 100Base-TX downlink PoE ports and 2 * 1000Base-TX uplink Ethernet ports featuring 30-watt 802.3at PoE+ as well as 1 additional Gigabit Combo port. The total PoE power budget is up to 270/390 watts. It supports web-based PoE management and real-time PoE output LED display. The device can be widely used in video security monitoring systems, network projects, etc.

1.2 Product Feature

- Provide 16/24x 100Mbps downlink PoE Ethernet ports, 2x gigabit uplink Ethernet ports and 1x gigabit Fiber port;
- Downlink Ethernet ports support PoE+, each port supports max. 30W output;
- Support power consumption indication(LED indicates power output status); support manage PoE on/off and power consumption setting via Web;
- Accord with IEEE802.3、IEEE802.3u、IEEE802.3ab、IEEE802.3 af/at standard;
- 4K MAC address,2.75Mb cache;
- Quick installation, easy operation, convenient for wall-mounted、desktop and rack installations.

1.3 Board Diagram

Front panel

24 Ports PoE switch

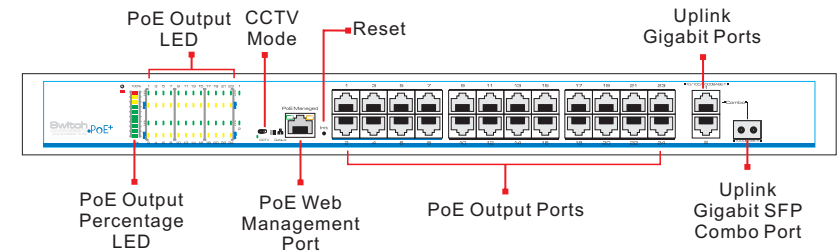

16 Ports PoE switch

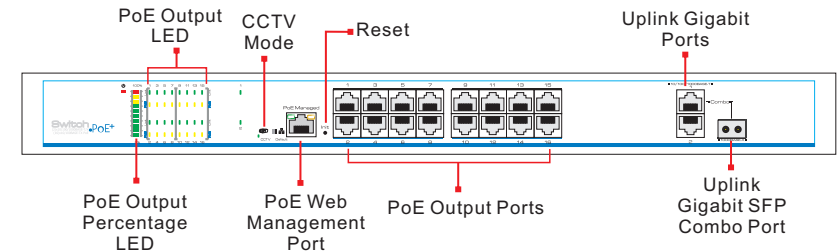

Back panel

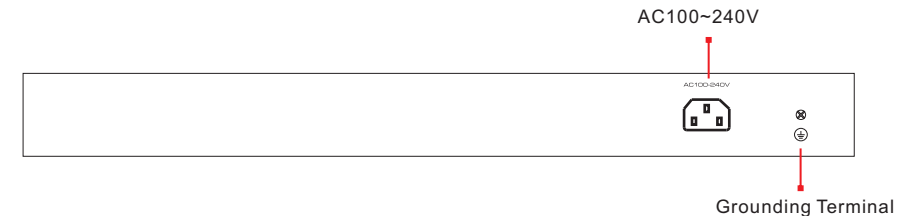

1.4 Specification

Item		Description	
Product Type	Product Type	16ports	24ports
Port Description	Downlink Ethernet Ports	16×RJ45,PoE+ 10/100Base-TX	24×RJ45,PoE+ 10/100Base-TX
	Uplink Ethernet Ports	2*10/100/1000Base-T+1*1000Base-X (combo)	
	Power Input	1×AC Female Terminal	
	Grounding Terminal	1×Grounding Terminal	
PoE&Power	Power Input	Mains on load,100~240VAC 50/60Hz	
	PoE Power Supply	End-span(1/2, 3/6),IEEE802.3 af/at	
	PoE Max. Power Output	270W	390W
	Single Port Power Output& Voltage	Single Port PoE Power Output≤30W, Voltage 54VDC	
PoE Web Management	PoE Management	Via Web(Default IP Address 192. 168. 1. 200) to check, on/off and adjust each port PoE output	
Reset Button	PoE Web Reset	Long-press 3s, all Link LED solid on about 10s, switch reset to factory default; short-press to restart.	
One-key CCTV	CCTV Mode	1. Downlink ports only communicate with uplink ports; 2. Restrain network storm under 2Mbps	
Network Parameters	Network Standard	IEEE 802. 3, IEEE 802. 3u, IEEE 802. 3 ab	
	Transmission Distance	100m(Max.)	
	Exchange Capacity	7. 2Gbps	8. 8Gbps
	Packet Transfer Rate	5.36Mpps	6.55Mpps
	MAC Address	4K	
	Packet Data Cache	2. 75Mb	
Indicators Status	Power Input	1x Red LED	
	Downlink Ethernet Ports	Link:16x Green LED PoE:16x Yellow LED	Link:24x Green LED PoE: 24x Yellow LED
	Uplink Ethernet Port Link	2x Green LED	
	PoE Power Output Percent	10x LED(Including 7x Green, 2x Yellow, 1x Red), separately indicate 10%、20%~100%	
Protection Level	ESD	6KV/ 8KV, Per: IEC61000-4-2	
	Surge Protection	6KV, Per: IEC61000-4-5	
Operation Environment	Operation Temperature	-10℃~45℃	
	Storage Temperature	-40℃~85℃	
	Humidity (Non-condensing)	0~95%	
Mechanics	Dimensions (LxWxH)	442mm*285mm*44. 5mm	

Products are subject to change without prior notice

Caution

Transmission distance is related with the cable, we suggest to use standard Cat5e/6 network cable to get the best transmission result.

2 Installation

Caution

Anti-counterfeiting label is attached to the injector's cover, so product damage caused by unauthorized disassembly is not covered under warranty.

2.1 Shipping List

Please check the following items before installation, if any missing, please contact your local dealer.

Item	Name	Quantity	Unit
1	Device	1	Set
2	AC Power Line	1	Piece
3	Accessories	1	Set
4	User Manual	1	Piece

2.2 Installation Precautions

To avoid device damage or personal injury by improper use, please observe the following precautions.

2.2.1 Safety Precautions

Instruction

This is level A product, which may cause radio interference in living environment. Users may need to take corresponding and effective measures to solve the problem.

- Pull out the power plug before cleaning the switch. Do not use wet cloth nor liquid to wipe or wash the switch;
- Do not leave the switch close to water or wet place so as to prevent water or dampness from entering into the switch;
- Make sure the switch work in a clean environment. Excessive dust may cause electrostatic adsorption, which will affect the equipment life and cause communication failure;
- The switch will work normally under the correct voltage. Please ensure the voltage indicated on the switch corresponds to the power voltage;
- To avoid the danger of electric shock, please do not open the switch case.
- Do not open the switch case even if the switch is powered off;
- The accessories (including but not limited to power lines, etc.), which can be used for the switch only, is prohibited for other applications.

2.2.2 Installation Requirements

The device should work in indoor environment to avoid thunder stroke. It is important to obey the following requirements no matter you install it in the cabinet or on the workbench directly:

- Enough space (larger than 10cm) for air outlet so as to facilitate the heating dissipation;
- Good ventilation system for cabinets and workbench;
- Cabinet and workbench is sturdy enough to support the injector and it's accessories's weight;
- Cabinet and workbench have good grounding.

2.2.3 The Requirements of Electromagnetic Environment

When it is working, the switch may be affected by external interference outside the system through the ways of radiation and conduction. Please pay attention to the followings:

- AC power supply is TN system, so it is necessary to use single phase power socket (PE) which can protect ground wire so that the filter circuit can effectively filter out the power grid disturbances;
- The switch should work far away from high-power radio transmitters, radar transmitters, high-frequency devices;
- Use electromagnetic shielding if necessary, such as shielded cable;
- Interface cables should be arranged indoor rather than outdoor to prevent over-voltage and over-current caused from damaging to the signal port.

2.3 Installation Way

There are 3 installation ways: rack, workbench and wall-hung installation.

⚠ Caution

Please pull out the power line before installing or moving the switch. Grounding and anti-lightening can greatly increase the protection level of the switch. please connect the earth terminal to the earth by using at least wire 20.

2.3.1 Rack Installation

Installation process :

- (1) Check rack grounding and stability;
- (2) Use screws to fit hangers at the device board side;



Figure 2-1 Install hangers diagram

- (3) Put the device on the rack's bracket and move the rack along the slot to proper position ;
- (4) Use screws to fit the installation hanger at rack's fixed slot, make sure the device is installed at rack's bracket steadily.



Figure 2-2 Install switch to the rack



Instruction

This product's installation hangers are just to fix the switch rather than support it. Use brackets under the device (fixed to the rack) to support switch when install the switch to the rack.

2.3.2 Workbench Installation

You can put this product on clean, stable, grounded workbench. The installation procedure is as below:

- (1) Put the device upside down carefully, clean the grooves on the chassis backplane with soft cloth to make sure there is no oil or dust in it;
- (2) Remove the stickers on the foot pad, paste the foot pad in backplane groove;
- (3) Put the device upright on the workbench.

2.3.3 Wall-hung Installation

You also can put the product on clean, steady vertical wall. Installation procedure is as below:

- (1) Use the screws to fix the hangers;



Figure 2-3 Hangers installation diagram

- (2) Drill holes on the solid position of wall and then drive the rubber plug into the hole;
- (3) Drive these screws into the hole for the rack and fix the product by aiming at the rubber plug .



Figure 2-4 Fix the switch on wall

2.4 Cable Connection

2.4.1 Device Connection

Use cross network cable or cross-over cable to connect PC or other device with switch's Ethernet port.

2.4.2 Configuration Cable Connection

Use a network cable to connect console port and management PC, use management PC to configure the PoE switch.



Figure 2-5 Connect configuration cable

2.4.3 Power Line Connection

- (1) Check if the selected power is the same as the power of switch;
- (2) Connect one side of switch's power line with the switch's AC power port, and connect the other side with AC power socket;



Figure 2-6 Power line connection

- (3) Check if switch's AC power indicate light is on. The light means power connected correctly.

3 PoE Web Management Page

This product has Web management function which allows users to control and manage PoE of each port by logging in on Web page.

3.1 Preparation Work

- Make sure the management PC has already been installed with Ethernet adapter;
- Use network cable to connect the console port with management PC.

3.2 Set Up Network Connection

Instruction

- (1) You need to set the management PC and this injector IP address under the same network segment, this product's default IP address is 192.168.1.200, gate is 255.255.255.0;
- (2) If you need to connect remote network, please make sure the management PC and the router can make this;
- (3) This product can't assign the IP address for the management PC, you need to set the management static IP by yourself.

3.2.1 Set Static IP Address of Managed PC

Operation steps (take Windows XP as sample):

- (1) Click <start> to enter the [start] menu, select "control panel". Double click "network connection" icon, double click the "local connection" icon, pop out "local connection status" window.

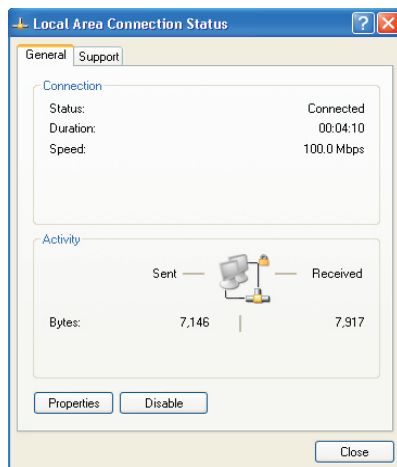

- (2) Click <property> button, enter "local connection property" window.

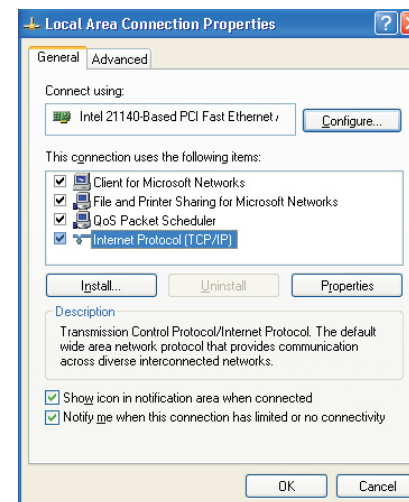

- (3) Select "Internet protocol (TCP/IP), click <property> button, enter "Internet protocol (TCP/IP) property" window. Select "use the IP address below" button, input IP address(use arbitrary value between 192.168.1.1~192.168.1.254, besides 192.168.1.200) and the subnet mask(255.255.255.0). Click "OK" to finish the configuration.

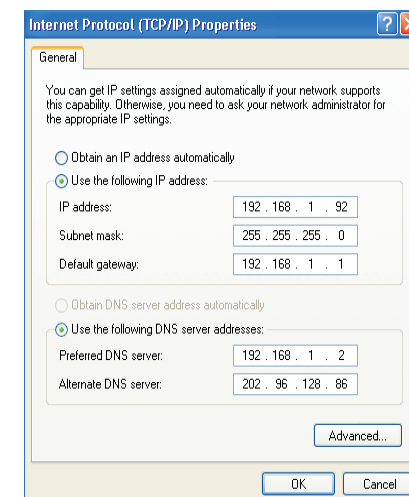

Instruction

DNS server address can be empty or be filled in with the real server address.

3.2.2 Confirm the Network Connection by Ping Command

Operation Steps as below:

(1) Click <Start> button to enter [Start] menu, select [Run], pop out the dialog.

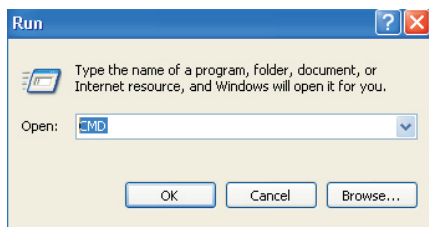

(2) Input "ping 192.168.1.200", click <confirm> button. If there is equipment response shown in the pop out dialog, that means network connection succeed, otherwise please check if the network connection is correct.

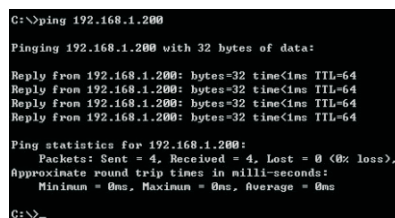

(2) Select "connection" tabs in [Internet option] window, and click [LAN Setting] button.

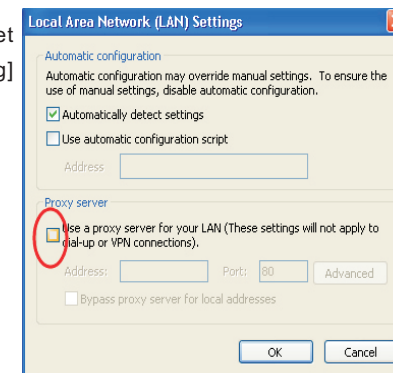

(3) Make sure the "Use proxy server for LAN" option is not selected. If selected, please cancel it and click <yes> button.

3.2.3 Cancel the Proxy Server

If this management PC uses proxy server to visit the Internet, then you must prohibit the proxy service, following is the operation:

(1) In browser, select [tool/Internet option] enter [Internet option] window.

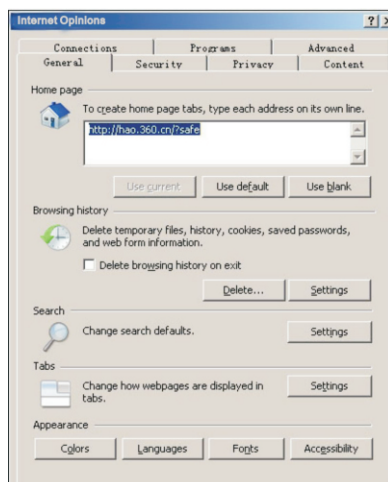

3.3 Operating Guidance of Web

The browser version recommended: IE7 and later, Firefox browser, Chrome, 360 browser (IE7 and later).

3.3.1 Start and Login

This product web default IP address: 192.168.1.200, subnet mask: 255.255.255.0, administrator account: admin, password: admin. After installing the equipment correctly and setting up the computer, open the browser, input the injector default address in the browser address bar: <http://192.168.1.200>, then press the Enter key, the user login page will show in front of you as follows:

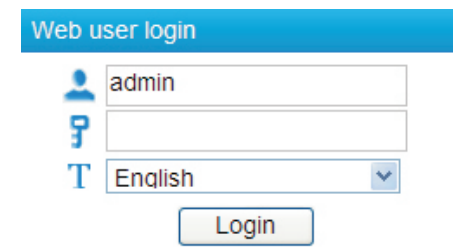



Caution

Please follow the steps to check if the injector is installed correctly:

(1) Whether the physical connection of the equipment is correct? The other end of the network line that is connected with computer network card must connect with the injector Console port, and ensure the link indicator light of the network port is on.

(2) Whether the computer TCP/IP agreement setting is correct? Your computer's IP address must be 192.168.1.x (x range is 1~254 and x cannot be 200, otherwise it will conflict with the product IP address: 192.168.1.200), subnet mask: 255.255.255.0.

After inputting the correct user name and password, click <Login> and the browser will show the product Web management page as the picture below:

PoE Manager | IP | Password | Factory Default | Device Info | Exit

PoE Setting (be careful for modification)

Power Provided 150 W Overload Limit 5 % Reserved Rate 15 %

Total Power Status

Consumed 0.0 W Remaining 127.5 W Reserved 22.5 W Provided 150 W

Port	ON	Power Device Description	Priority	Power Limited (W)	Power Consumed (W)	OK
1	ON	port1	I n/w	30.0	0.0	OK
2	ON	port2	I n/w	30.0	0.0	OK
3	ON	port3	I n/w	30.0	0.0	OK
4	ON	port4	I n/w	30.0	0.0	OK
5	ON	port5	I n/w	30.0	0.0	OK
6	ON	port6	I n/w	30.0	0.0	OK
7	ON	port7	I n/w	30.0	0.0	OK
8	ON	port8	I n/w	30.0	0.0	OK

Notice

Diagram of Web English management page

3.3.2 Operating Instruction of Web

3.3.2.1 Change Language

As shown in the picture below, press the drop-down list at the icon T, choose "Chinese" or "English" to achieve Web page language, as the picture below.



The diagram of language change page

3.3.2.2 Setting IP Address

(1) Click the Web management page menu bar "IP", then It will popup a dialog box of setting IP address.

Set IP

IP Address: 192 . 168 . 1 . 200

Subnet Mask: 255 . 255 . 255 . 0

Default Gateway: 192 . 168 . 1 . 1

(2) Change product IP address, subnet mask and gateway at the dialog box of setting IP address, such as change the IP address to 192.168.2.200, keep subnet mask unchanged, and change default gateway to 192.168.2.1.

Set IP

IP Address: 192 . 168 . 2 . 200

Subnet Mask: 255 . 255 . 255 . 0

Default Gateway: 192 . 168 . 2 . 1

(3) After changing the IP address, press the "OK" button and wait for 10 seconds till product IP address is successfully changed.

Caution

- (1) When product IP address is changed, please ensure that the computer IP address and the product IP address must be in the same network segment and the settings of subnet mask and gateway must be correct.
- (2) When changing product IP address, please ensure the power supply to avoid abnormal problems.
- (3) What to do if you forget the IP address of the product? Please refer to 3.3.2.5 restore the initial setting.

3.3.2.3 Change Password

Login password: the product only provides one user name “admin”, default password is “admin”, Please change the password in time for system safety and the password length must be between 5~20, The change will take effect on next login.

(1) Click the Web management page menu bar [change password], then it will pop up a dialog box of changing password.

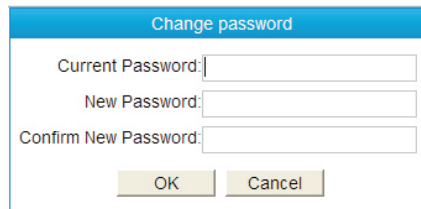

A dialog box titled "Change password" with three input fields: "Current Password:", "New Password:", and "Confirm New Password:". Below the fields are "OK" and "Cancel" buttons.

(2) Enter the product current password and the new password, then confirm the new password.

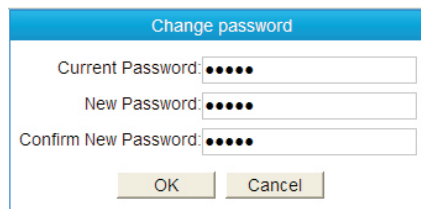

A dialog box titled "Change password" with three input fields: "Current Password:", "New Password:", and "Confirm New Password:". The input fields are masked with dots. Below the fields are "OK" and "Cancel" buttons.

(3) Click the <ok> key and then a dialog box as the picture will pop up, click <Close>.

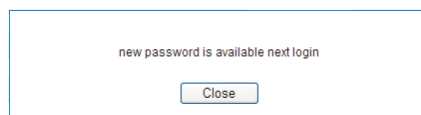

A dialog box with the text "new password is available next login" and a "Close" button.

Caution

What to do when the password is forgotten?
Please refer to 3.2.2.4 to restore IP address and password.

3.3.2.4 Restore the Initial Setting

(1) Click menu bar [restore the initial setting] on the Web page, popup dialog box as shown below:

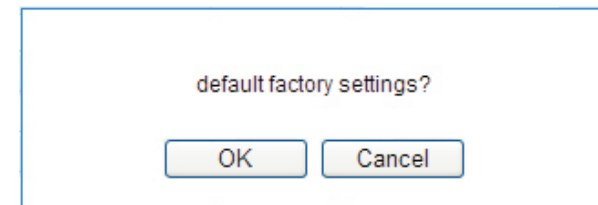

A dialog box with the text "default factory settings?" and two buttons: "OK" and "Cancel".

Restore the initial setting

- (2) Click <Ok> button and restore the initial setting, press <Cancel > button to cancel the restore of the initial setting.
- (3) After pressing <Ok> button, wait for 10 seconds, the product restores the initial setting.

Caution

To restore the initial setting means to restore two menu configuration information of [PoE setting] and [Port status and control] in the Web to factory default setting, please use in caution.

3.3.2.5 Restore IP Address and Login Password

Start the product, unplug the network cable of console port, then press init key(3~5 seconds), till the RJ45 LED light of console port flash once, the IP address and login password will be restored to the initial setting.

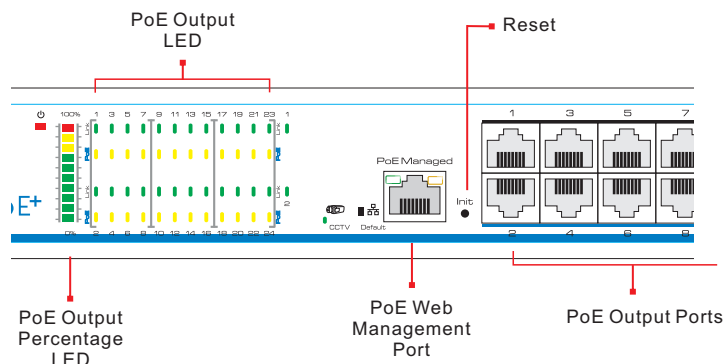

Diagram of restore IP address, login password

3.3.2.6 Equipment Information

Click menu bar [equipment information] on Web page, then three product information of [IP address], [MAC address] and [software version] will be popped out for user checking. After review, click <Exit> to log out checking status.



Equipment information diagram

3.3.2.7 Exit

Click main menu [Exit] to return to login page.

3.3.2.8 PoE Setting



Diagram of PoE setting page

- (1) Power input: The total power provided by the product for PoE supply, i.e. the power provided by built-in 54V power, has been set up when it leaves the factory, please do not modify it. If users modified the power supply, please correct this setting. If the setting value is larger than the actual power of the built-in power supply, there will be a damage of built-in power. If the setting value is smaller than the actual power of built-in power supply, built-in power supply could not be fully allocated out.
- (2) Allowing maximum overload: built-in power allows overload value setting range is 0%-10%, default is 5%. If actual power is too large that cause built-in power overload exceeding setting value, the system will turn off power supply of low priority ports. For example: when input power is 360w, maximum overload is 5%. when actual output power exceeds $360 \times (1+5\%) = 378w$, the system overloads.
- (3) Power Reservation: power reservation could not be contributed, but be used for PoE equipment consumption due to load changes. Default power reservation is 15% of total power. The higher the value, the slower the risk of system overload, the power to be contributed decreases, and the number of PoE equipments to be connected decreases; on the contrary, the more the number of PoE equipments to be connected, the higher risk of system overload.
- (4) Operation instructions: after setting the value, press <OK> button. Setting succeeds when the following window pops out.

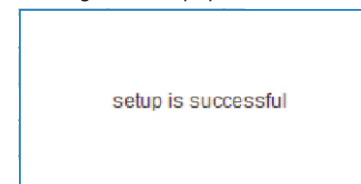

Instruction

The input power, allowing maximum overload and reserved power have been set up before the product leaves the factory. User is allowed to modify it, prudently.

3.3.2.9 Power Status



Power status page diagram



- (1) Actual output: total actual output power .
- (2) Surplus: the power to be used for redistribute. Surplus=input-actual output-reservation, please noted that the product distributes power according to power level of detected PoE powered device when connecting a new PoE powered device, instead of according to the actual power of newly connected PoE powered device. For example: when surplus power is 20W , if the power level of the connected PoE powered device is 25.5W, the system could not distribute power for it even if the actual power only need 10W, which means it cannot be powered.
- (3) Reservation: used for PoE powered device due to load changes caused by consumption, from parent menu setting "input power * reserve power".
- (4) input : The total power of the system, from parent menu "input power" .

- (3) Priority: there are three port power supply priority levels: low, medium and high. when system overloads, the power supply of low priority port will be disconnected firstly.
- (4) Allowed maximum output power: set single port's limited output power, the port will be disconnect with power supply once actual power exceeds this value. Each port of the product provides max 30W output power. If user setting exceeds 30W, the maximum output power will only be 30W.
- (5) Actual output power: port's actual output power .
- (6) Fault status alarm: The following situations will cause warning information on [prompted message]:
 - Surplus power lower than 10W;
 - Total power overloads ;
 - Linked PoE powered device's (PD) port disconnected.
- (7) Operation instructions :

3.3.2.10 Port Status and Control

Port Status and Control						
Port	<input type="checkbox"/>	Power Device Description	Priority	Power Limited (W)	Power Consumed (W)	<input type="button" value="OK"/>
1	<input type="checkbox"/>	port1	I low	30.0	0.0	<input type="button" value="OK"/>
2	<input type="checkbox"/>	port2	I low	30.0	0.0	<input type="button" value="OK"/>
3	<input type="checkbox"/>	port3	I low	30.0	0.0	<input type="button" value="OK"/>
4	<input type="checkbox"/>	port4	I low	30.0	0.0	<input type="button" value="OK"/>
5	<input type="checkbox"/>	port5	I low	30.0	0.0	<input type="button" value="OK"/>
6	<input type="checkbox"/>	port6	I low	30.0	0.0	<input type="button" value="OK"/>
7	<input type="checkbox"/>	port7	I low	30.0	0.0	<input type="button" value="OK"/>
8	<input type="checkbox"/>	port8	I low	30.0	0.0	<input type="button" value="OK"/>
9	<input type="checkbox"/>	port9	I low	30.0	0.0	<input type="button" value="OK"/>
10	<input type="checkbox"/>	port10	I low	30.0	0.0	<input type="button" value="OK"/>
11	<input type="checkbox"/>	port11	I low	30.0	0.0	<input type="button" value="OK"/>
12	<input type="checkbox"/>	port12	I low	30.0	0.0	<input type="button" value="OK"/>
13	<input type="checkbox"/>	port13	I low	30.0	0.0	<input type="button" value="OK"/>
14	<input type="checkbox"/>	port14	I low	30.0	0.0	<input type="button" value="OK"/>
15	<input type="checkbox"/>	port15	I low	30.0	0.0	<input type="button" value="OK"/>
16	<input type="checkbox"/>	port16	I low	30.0	0.0	<input type="button" value="OK"/>
17	<input type="checkbox"/>	port17	I low	30.0	0.0	<input type="button" value="OK"/>
18	<input type="checkbox"/>	port18	I low	30.0	0.0	<input type="button" value="OK"/>
19	<input type="checkbox"/>	port19	I low	30.0	0.0	<input type="button" value="OK"/>
20	<input type="checkbox"/>	port20	I low	30.0	0.0	<input type="button" value="OK"/>
21	<input type="checkbox"/>	port21	I low	30.0	0.0	<input type="button" value="OK"/>
22	<input type="checkbox"/>	port22	I low	30.0	0.0	<input type="button" value="OK"/>
23	<input type="checkbox"/>	port23	I low	30.0	0.0	<input type="button" value="OK"/>
24	<input type="checkbox"/>	port24	I low	30.0	0.0	<input type="button" value="OK"/>

Prompt Messages

- (1) Port number: corresponding to the port numbers on product board,  indicates unlinked PoE powered device or linked PoE powered device without power supply,  indicates linked PoE powered device and normal supply.
- (2) Powered device location: a brief description of installation location of powered device's each port.

- Open single port: press corresponding port OFF , after setting success, popup "setting success" prompt, and the corresponding button becomes ON the system will check whether the port is connected with PoE powered device (PD) automatically. It starts power supply when checking OK.
- Close single port: press corresponding port ON and popup dialog box. Take port 1 as an example, press <OK>, popup "setup is successful". When setting succeeds, corresponding button becomes OFF .

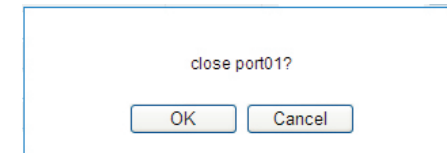

- Open all the ports: press title bar Port OFF , then popup dialog box as the figure shown :

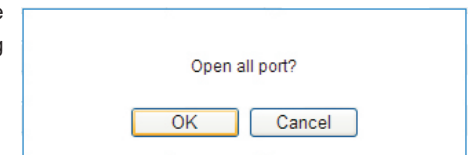

Press <OK>, when all the port opens, popup “setting success”, the button turns to ON status.

- Turn off all the ports: press title bar Port ON button, popup dialog box as shown below:

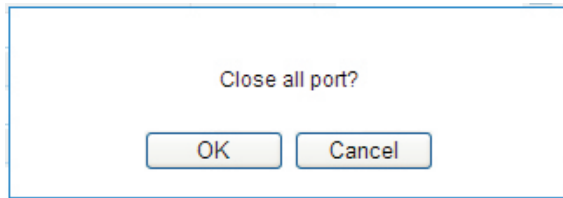

Press <OK>, when all the ports open, popup “setup is successful”, the button become OFF status.

- Setting single port parameters : port parameters include powered device location, priority and allowed maximum output power. After setting parameters, press <OK> button of the corresponding port, then popup “setting success” when operation finishes .
- Setting all the port parameters : press [port control and status] [actual output power(W)] OK button, then popup dialog box as shown below:

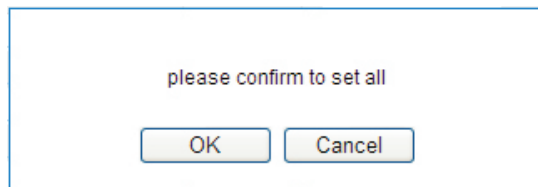

Press <OK>, when all the setting finishes, popup “setup is successful”.

- Setting unified allowed maximum output power: as shown below:

Port Status and Control						
Port	<input type="checkbox"/> ON	Power Device Description	Priority	Power Limited (W)	Power Consumed (W)	<input type="checkbox"/> OK
				30 <input checked="" type="checkbox"/>		

After selecting the check box, all the ports allow maximum output power depends on this value.

3.4 Typical Application

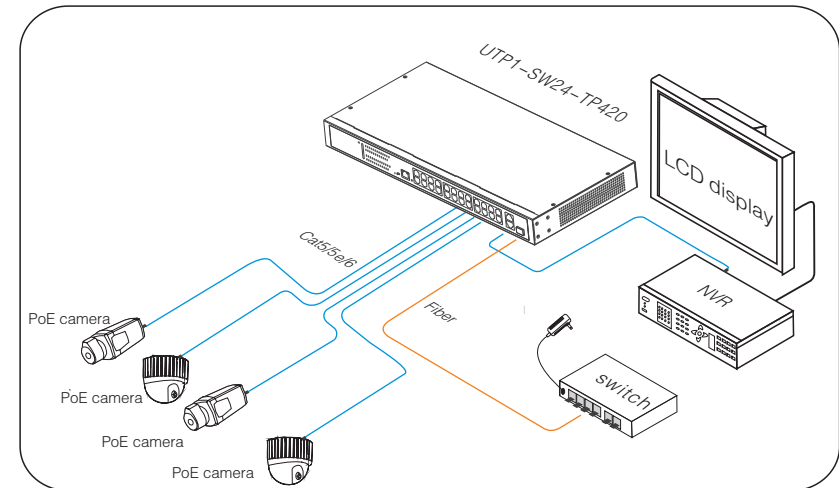

3.5 Trouble Shooting

Please find the following solution when the device doesn't work

Please confirm the installation is correct;

Please confirm whether the sequence of RJ45 cable meet the EIA/TIA568A or 568B industry standards;

Please replace device which can not work with a properly working one to check whether the device is broken;

Please contact the factory if the problem stays unsolved.

Environment protection

This product design is environmental friendly. Please store, use and discard this product in accordance with the relevant national legal/ regulatory requirements.